

# AlerTox<sup>®</sup>•Sticks

## Sesame

Immunochromatographic rapid test for qualitative detection of sesame antigen in food, kitchens and production facilities.

# AlerTox® Sticks

## Sesame

### Contents

1. Intended use.....	3
2. Introduction.....	3
3. Test sensitivity and specificity .....	3
4. Kit contents.....	3
5. Other materials not supplied .....	3
6. Precautions.....	4
7. Sample handling.....	4
8. Test procedure for solid foods.....	4
9. Test procedure for liquid samples .....	5
10. Test procedure for surface analysis.....	6
11. Interpretation of results.....	8
12. Validation .....	8

## 1. Intended use

AlerTox® Sticks Sesame is an immunochromatographic rapid test for the qualitative detection of sesame antigen in food, kitchens and production facilities.

## 2. Introduction

Sesame is an herbaceous plant belonging to the family Pedaliaceae; most common species are *Sesamum indicum* (white sesame) and *Sesamum radiatum* (black sesame).

Allergy to sesame seeds as well as products based on them can display the variety of symptoms from mild oral allergy or hives to severe life-threatening systemic reactions, i.e. anaphylactic shock or bronchial asthma. Allergy to sesame seeds is estimated 0.1 - 0.9% prevalence in population, it is more common in Asian countries. Sensitized patients may cross-react with peanuts, walnuts, hazelnuts, rye and poppy seeds.

In the EU, sesame seed is included in the list of allergens established by the European Food Safety Authority, whose presence must be indicated in foods according to Regulation (EU) No. 1169/2011 Annex II. UK, Australia, Canada and Israel are among the regions where sesame is considered as major food allergen and must be specifically declared on the labels. In the USA, sesame seed rates number 9 by frequency among food allergies, especially affecting young children and labeling is required as of Jan. 1, 2023.

## 3. Test sensitivity and specificity

AlerTox® Sticks Sesame uses a combination of monoclonal antibodies against a sesame antigen, the 2S seed storage protein (2S albumin) known as allergen Ses i2, that detect antigens in white sesame and black sesame. AlerTox® Sesame does NOT detect the antigens of cereals, legumes, nuts and other seeds.

The LOD (limit of detection) of AlerTox® Sticks Sesame is 3 ppm of sesame seed protein. The range of detection (ROD) is 3-20000 ppm. Above this range, the test can present a hook effect. The hook effect can appear as a negative result or as a test line with reduced intensity. If a false negative due to hook effect is suspected, repeat the test on a diluted sample.

The LOD of peeled sesame seeds is slightly higher and the ROD is 10-20000 ppm. On dry surfaces collected by a wet swab, the LOD is approximately 3,5ug of sesame protein/16cm<sup>2</sup>.

**The sensitivity of the test decreases in an environment rich in fats (for example, in the presence of oil or creams).**

If you need to quantify the amount of antigen, please acquire AlerTox® ELISA Sesame (KIT3051)

## 4. Kit contents

- 10 immunochromatographic sticks individually packed in foil pouches
- 10 sample collection tubes (tube with yellow cap)
- 10 sample extraction buffer tubes, 10 mL (tube with blue cap)
- 10 spoons
- 10 pipettes (3mL - only for testing liquid samples)
- 10 small pipettes
- 10 swabs (only for testing surfaces)
- Instructions for use (download from webpage)

## 5. Other materials not supplied

- Grinder, mortar or any other manual or automatic homogenization system to crush the sample
- Scissors
- Optional: digital scale sensitive to 0.1 g

## 6. Precautions

- The test sticks must be stored at a temperature between 10 °C and 30 °C (50 °F and 86 °F).
- Use the test within 10 minutes after opening the foil pouch.
- Do not touch the white end of the stick.
- Do not use the test stick when its pouch is torn, or the stick is broken or damaged.
- All the components of the test kit are disposable; do not reuse them.
- Do not use the test sticks beyond the expiry date.



## 7. Sample handling

The samples must be brought to a temperature between 18 °C and 35 °C (64.4 °F and 95 °F) before use. The test is designed to detect the target antigen in:

- Solid food
- Liquid samples: beverages, rinse water from cutting equipment, and surfaces used in food processing and storage
- Surfaces

## 8. Test procedure for solid foods

- 8.1.** Before opening the foil pouch containing the test stick, please leave it at room temperature while you process the samples.
- 8.2.** Mash or crush the sample to obtain the finest crumbs possible. Use a mortar or a grinder if possible.
- 8.3.** Use a scale to weigh 1g of the sample, or follow the chart below to add an equivalent amount of sample to a yellow-capped tube, using one of the single-use spoons provided.

Food type	Examples	Spoonfuls
Flours, fine powders	Corn flour, rice flour, milk powder, spices, etc.	
Fine crumbs	Bread, cookies, cakes, snacks, etc.	
Meat, fish and cured meat	Meat, fish, sausage, black pudding, pâtè, canned meat and fish, etc.	

- 8.4.** Pour the entire content of a blue-capped tube (10 mL) into the yellow-capped tube.  
**Keep the blue cap, as it will be used later on.**
- 8.5.** Close the yellow-capped tube and shake it vigorously for at least 20 seconds. Let it rest for 2 minutes so the solids settle.
- 8.6.** With a small pipette, transfer supernatant to the blue cap until it is full.
- 8.7.** Open the envelope and pull out the stick carefully, by holding its BLUE end. Do **NOT** touch the white end of the stick.
- 8.8.** Place the white end of the stick in the blue cap and wait 10 minutes to read the result. Do not leave the stick longer than indicated, as the results may vary. Do not touch the stick while waiting.

## Test procedure for solid foods

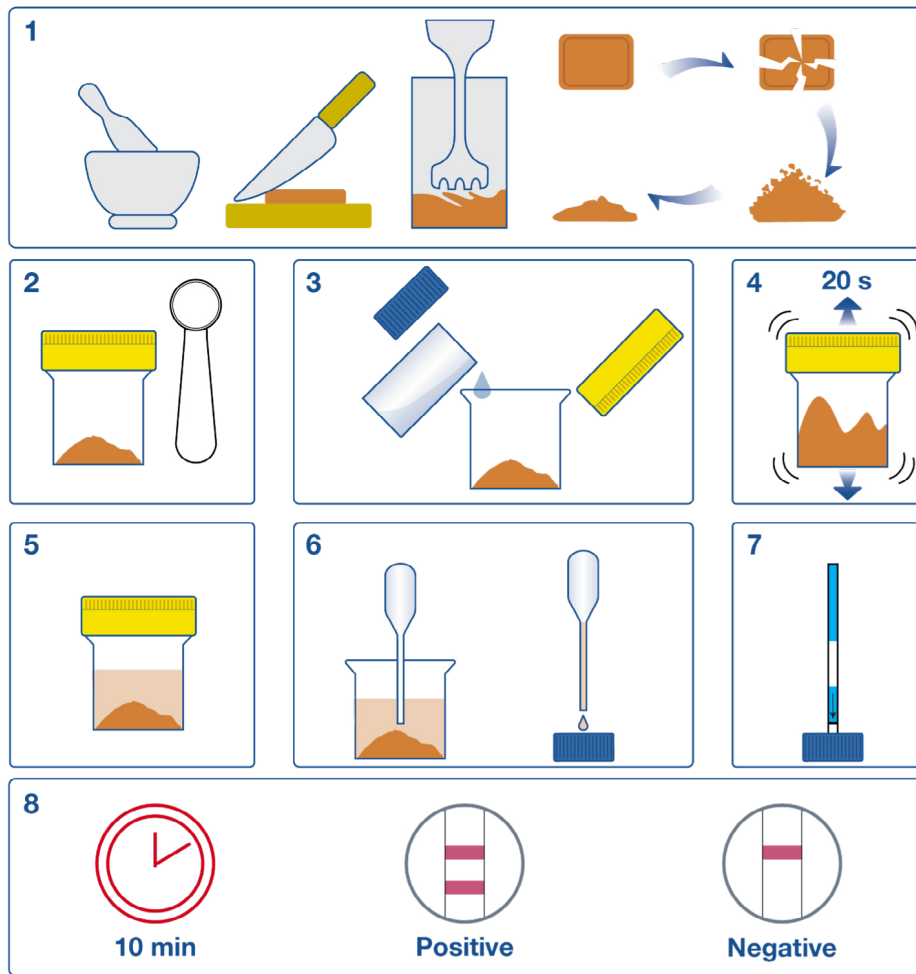

## 9. Test procedure for liquid samples

Liquid samples – beverages, washwaters from kitchen dishes, technological surfaces or cutting machines – may be tested directly. Turbid samples should be filtered (paper or textile filter) or allowed to settle.

- 9.1. Before opening the foil pouch containing the test stick, please leave it at room temperature while you process the samples.
- 9.2. Using a provided 3 mL pipette, add 3 mL of your liquid sample to a yellow-capped tube. If the sample is thick (e.g., yogurt, sauce, etc.), follow the chart below to add an equivalent amount of sample to the yellow-capped tube, using one of the single-use spoons provided.
- 9.3. Add an equal volume of sample extraction buffer (3 mL) using the same pipette, screw on the yellow cap and mix by gently shaking the tube for at least 20 seconds. If the liquid is cloudy, let it settle.  
**Keep the blue cap, as it will be used later on.**
- 9.4. With a small pipette, transfer supernatant to the blue cap until it is full.
- 9.5. Open the envelope and pull out the stick carefully by holding its BLUE end. Do **NOT** touch the white end of the stick.
- 9.6. Place the white end of the stick in the blue cap and wait 10 minutes to read the result. Do not leave the stick longer than indicated, as the results may vary. Do not touch the stick while waiting.

Food type	Examples	Spoonfuls
Liquid and sauces	Milk, juice, condensed milk, yogurt, soup, gravy, sauce, cream, etc.	

## Test procedure for liquid samples

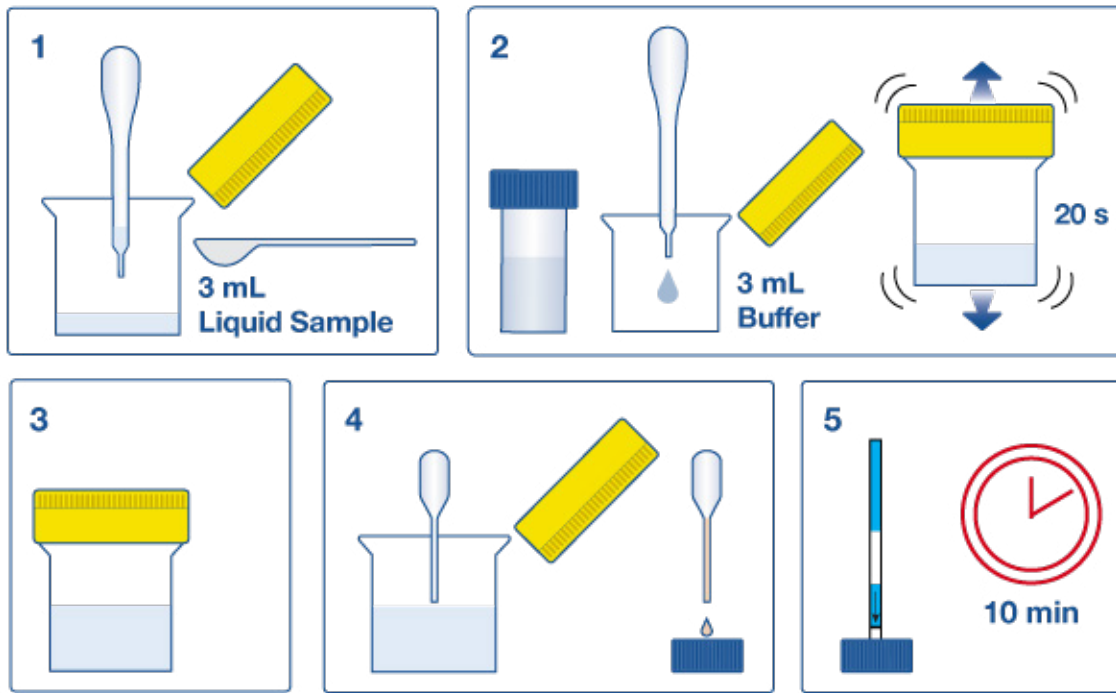

## 10. Test procedure for surface analysis

- 10.1.** Wet the swab by dipping it in the blue-capped tube. Firmly rub the swab on the surface that is going to be analyzed (at least 16 cm<sup>2</sup>/2.46 in<sup>2</sup>, or a line of 40 cm/15.6 in). The area selected for analysis must be representative of the total area of interest.
- 10.2.** Introduce the swab into the sample collection tube and, using scissors, trim the swab so that it will fit in the yellow-capped tube with the cap closed.
- 10.3.** Pour the entire content of a blue-capped tube (10 mL) into the yellow-capped tube.  
**Keep the blue cap, as it will be used later on.**
- 10.4.** Vigorously shake the tube for at least 20 seconds.
- 10.5.** With a small pipette, transfer supernatant to the blue cap until it is full.
- 10.6.** Open the envelope and pull out the stick carefully by holding its BLUE end. Do **NOT** touch the white end of the stick.
- 10.7.** Place the white end of the stick in the blue cap and wait 10 minutes to read the result. Do not leave the stick longer than indicated, as the results may vary. Do not touch the stick while waiting.

# Test procedure for surface analysis

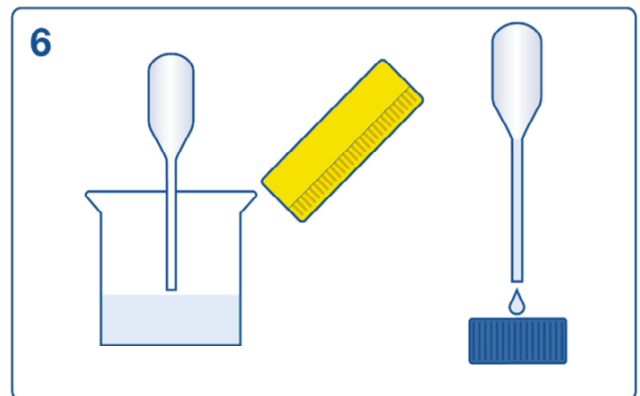
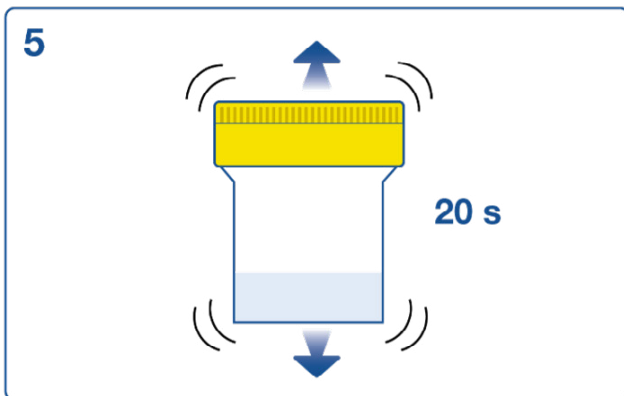
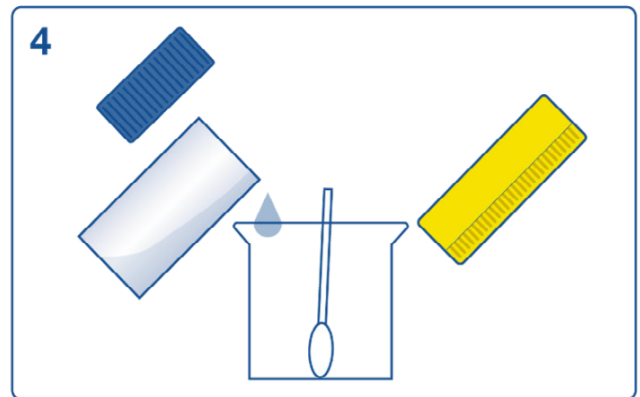
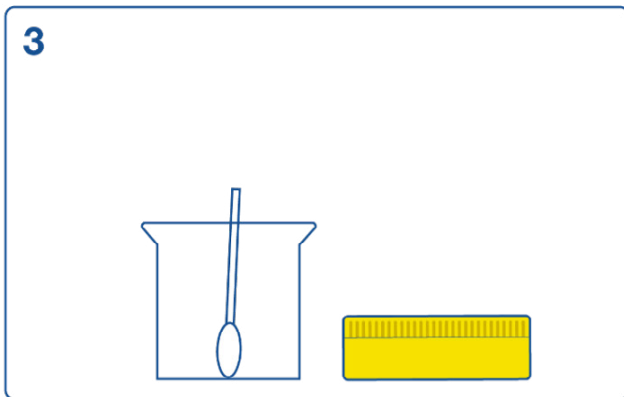
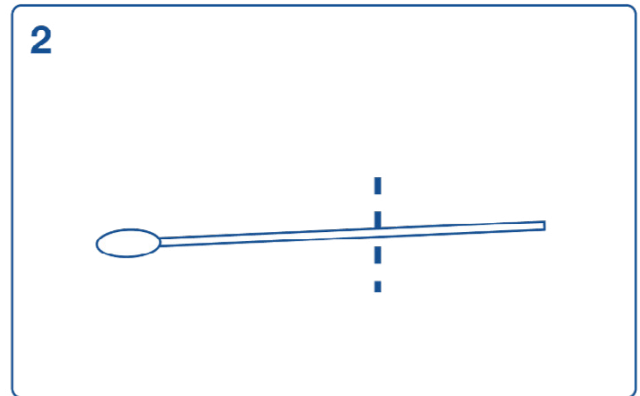
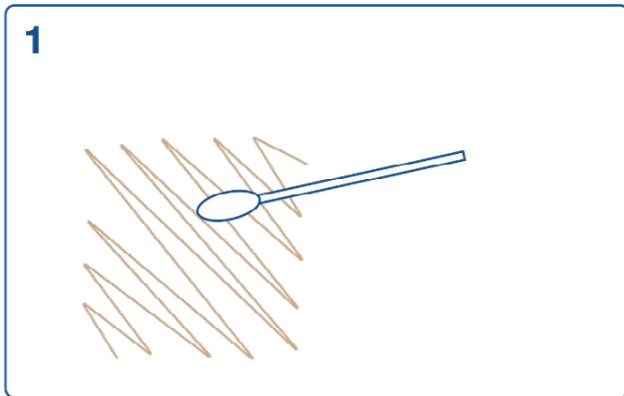

## 11. Interpretation of results

The result of the test is POSITIVE if TWO colored lines appear: one in the control zone (C) and one in the test zone (T).

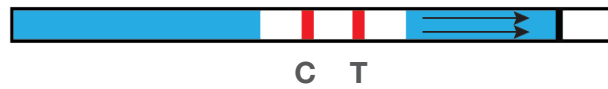

The result of the test is NEGATIVE if only ONE colored line is clearly visible in the control zone (C).

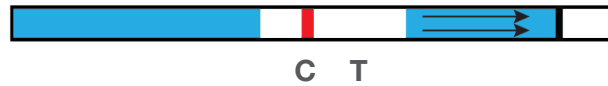

If NO colored line appears in the control zone (C), the test is INVALID.



In the case of an invalid test, repeat the test with another stick, check the correct specimen handling and test procedure, expiry date and storage conditions. Contact your distributor for further details.

### IMPORTANT NOTE!

**AlerTox® Sticks is a qualitative test intended for the screening of samples for internal quality control. Under no circumstances can it replace the quantification test of the laboratory analysis.**

## 12. Validation

AlerTox® Sticks Sesame has been validated for the following matrices:

- White, black and peeled sesame
- Nut sauce
- Sesame oil (negative)
- Bread, buns and breadsticks
- Granola bar
- Cookies, waffles and pastries
- Cereal biscuits
- Nut and chocolate biscuits
- Soft cakes
- Chocolate and chocolate bars, protein and energy bars
- Spreads (nut and peanut butter)
- Tahini
- Yogurt / dairy based desserts
- Nut ice cream
- Tree nut and cereal drinks





83 Rue Edmond Michelet  
69490 Pontcharra-Sur-Turdine  
France

Tel : +33 (0)4 74 13 03 02

Fax : +33 (0)4 74 05 28 25

Mail : [info@libios.fr](mailto:info@libios.fr)

Web : [www.libios.fr](http://www.libios.fr)

